

Serie "GT3"
"GT3" series

CM 415

CE



EN 14439 C25

DIN 15018-H1/B3

PROGETTO e COSTRUZIONE / DESIGN and CONSTRUCTION:
LUIGI CATTANEO S.p.A

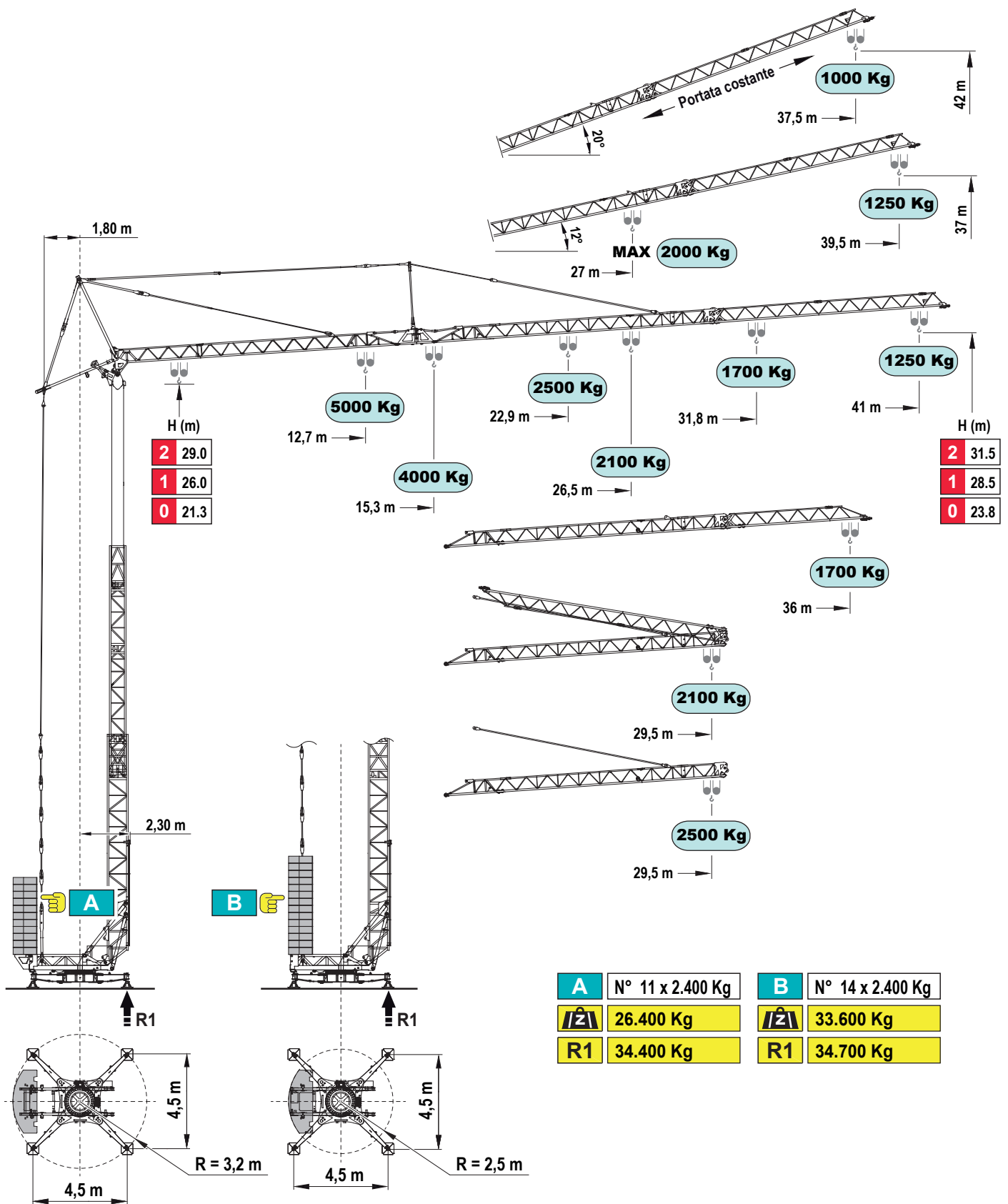









| H (m) | |
|-------|------|
| 2 | 29.0 |
| 1 | 26.0 |
| 0 | 21.3 |

| H (m) | |
|-------|------|
| 2 | 31.5 |
| 1 | 28.5 |
| 0 | 23.8 |

| A | N° 11 x 2.400 Kg | B | N° 14 x 2.400 Kg |
|----|------------------|----|------------------|
| | 26.400 Kg | | 33.600 Kg |
| R1 | 34.400 Kg | R1 | 34.700 Kg |

| | kg | 5000 | 4000 | 3000 | 2500 | 2100 | 1700 | 1250 |
|-------------------|----|------|------|------|------|------|------|------|
| Curve di carico | m | 12.7 | 15.3 | 19.5 | 22.9 | 26.5 | 31.8 | 41.0 |
| Load diagrams | m | 14.3 | 17.3 | 22.0 | 26.0 | 30.0 | 36.0 | |
| Courbes de charge | m | 14.1 | 17.0 | 21.6 | 25.3 | 29.5 | | |
| Lastkurven | m | 16.1 | 19.6 | 25.0 | 29.5 | | | |
| Curvas de cargas | m | | | | | | | |

Prestazioni - Performances - Prestations - Leistungen - Prestaciones

|  |  kVA |  400V - 50Hz 20 kVA | | | | | |
|---|--|---|---|-----------------|-------|-------|-------|
| | |  | 1° 2° 3° 4° | | | | |
|  inverter | 12,5 | |  | m/min | 3,5 | 14 | 27 |
| | | kg | | 5.000 | 5.000 | 2.500 | 1.250 |
|  inverter | 3,0 | Kg 0 → 3.000 | m/min | 18 - 37 - 50 | | | |
| | | Kg 0 → 5.000 | m/min | 18 - 37 | | | |
|  inverter | 5,5 | | g/min | 0,2 - 0,5 - 0,9 | | | |

Montaggio - Erection - Montage - Montage - Montaje

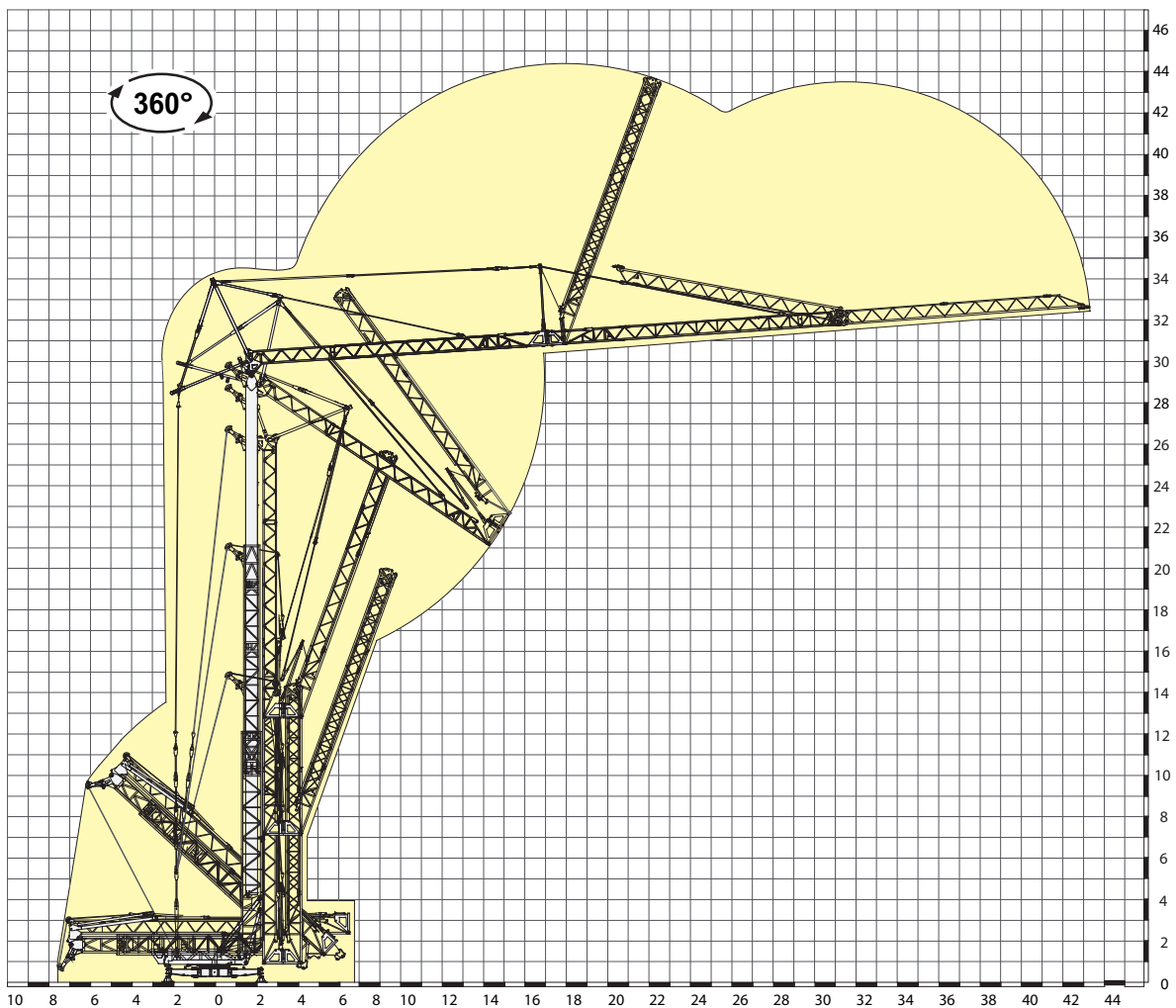

Documento commerciale non contrattuale - This commercial document is not legally binding
 Document commercial non contractuel - Unverbindliches Vertriebsdokument
 Documento comercial no contractual

CM 415

 **20.600 kg** 

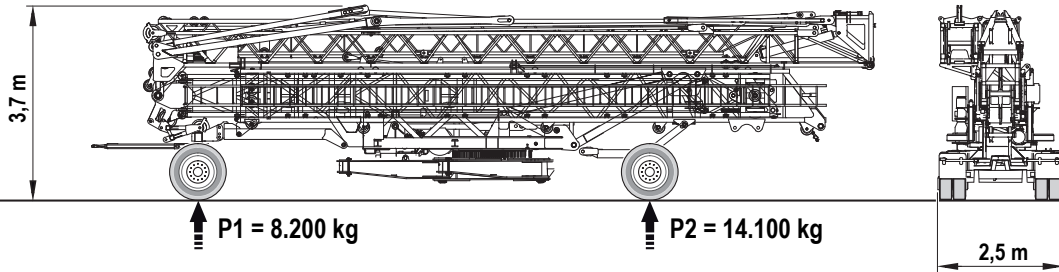
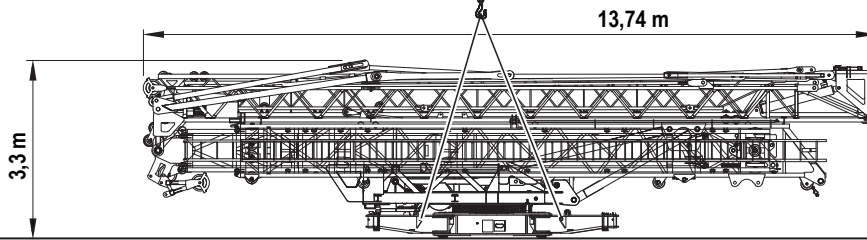

T1S1

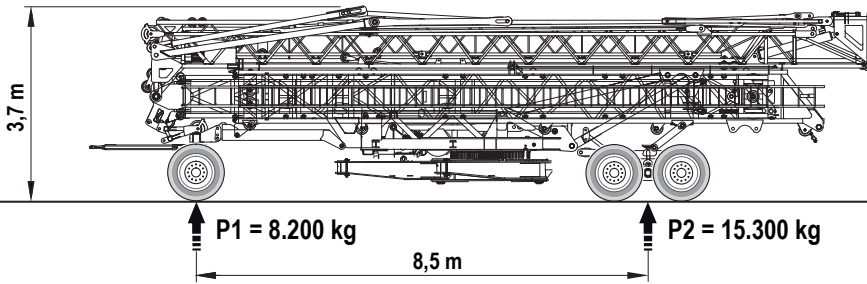

25 Km/h

R120

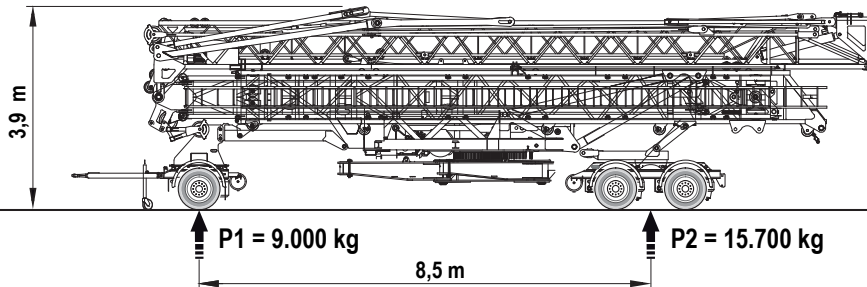

Otto 80 Km/h
Dir. 2007/46/CE

S020

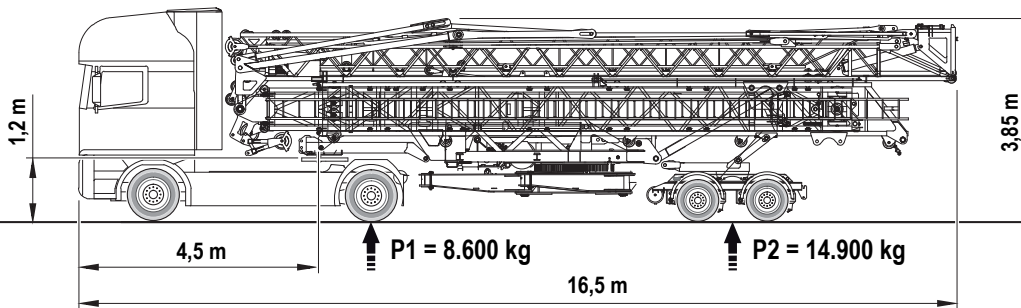

Otto 80 Km/h
Dir. 2007/46/CE

N°2 container 40' open top

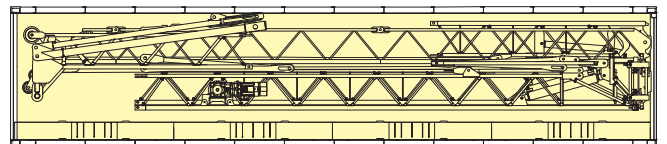
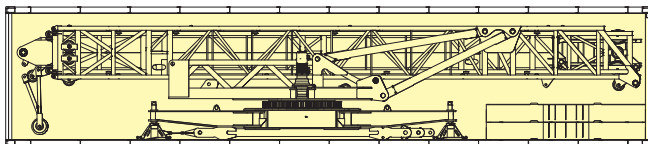

Specifiche suscettibili di variazioni senza preavviso - Specifications subject to modification without notice - Spécifications susceptibles de modification sans avis préalable
Technische Daten und Angaben unter Vorbehalt - Especificaciones susceptibles de variación sin previo aviso